

MOP125x50-Ø20

EAN 4031582320015

wielkern van polyamide, naaf op precisiekogellager,
extra zware Heavy Duty uitvoering

Technische data

Wieldiameter	125 mm
Bandbreedte	50 mm
Asgat-Ø	20 mm
Naaf lengte	60 mm
Temperatuur	- 40 / + 80 °C
Standaard	EN 12533
Eigen gewicht	1.112 kg
Dyn. draagvermogen	1700 kg
Statisch draagvermogen	3400 kg
Hardheid van de band	D 75 Shore
Lager	6304 Nr.



Rolweerstand	+	+	+	+	+
Verplaatsingsgeluid	+	+	+	+	+
Strepen	+	+	+	+	+
Roest bescherming	+	+	+	+	+

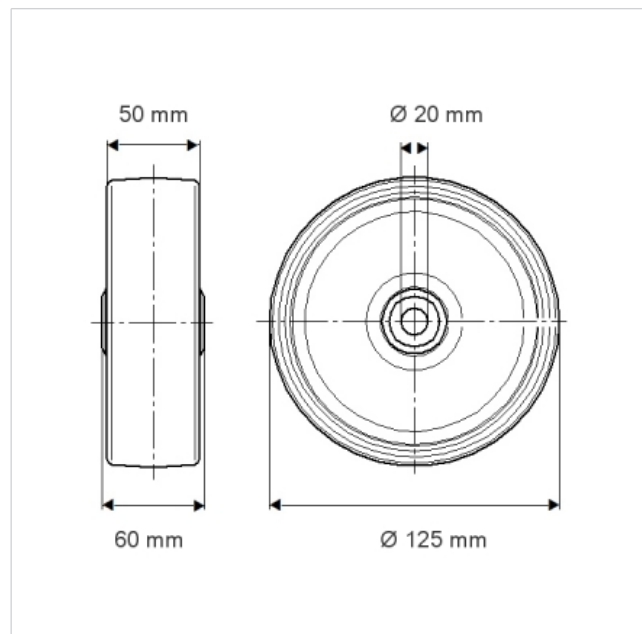



MOP125x50-Ø20

EAN 4031582320015

