

ITP200x50-Ø20 flat

EAN 4031582070330

wielkern van aluminium met gegoten polyurethaan loopvlak, precisiekogellagers,

Technische data

Wieldiameter	200 mm
Bandbreedte	50 mm
Asgat-Ø	20 mm
Naaflengte	60 mm
Temperatuur	- 20 / + 60 °C
Standaard	EN 12533
Eigen gewicht	1.44 kg
Dyn. draagvermogen	800 kg
Statisch draagvermogen	1600 kg
Hardheid van de band	A 92 Shore



Rolweerstand	+	+	+	+	+
Verplaatsingsgeluid	+	+	+	+	+
Strepen	+	+	+	+	+
Roest bescherming	+	+	+	+	+

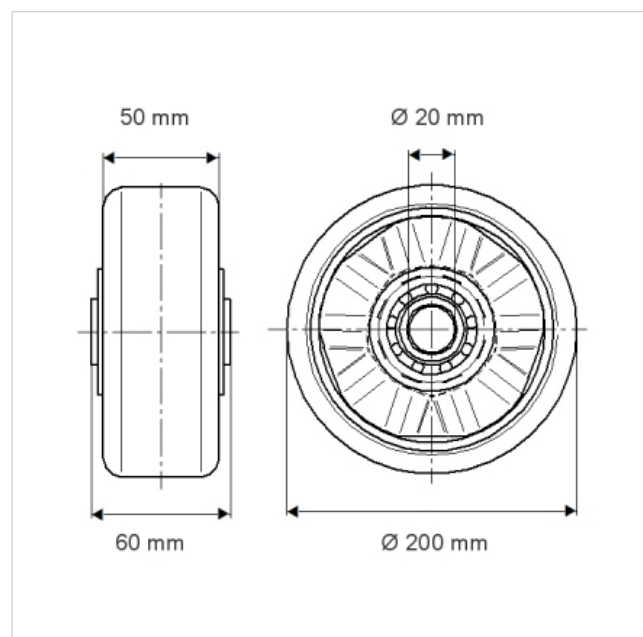



ITP200x50-Ø20 flat

EAN 4031582070330

