

ETP075x40-Ø20 HL40

EAN 4031582318487

wielkern van staalplaat met gegoten polyurethaan loopvlak, naaf op precisiekogellager

Draagvermogen op een gladde, vlakke vloer.

Technische data

Wieldiameter	75 mm
Bandbreedte	40 mm
Asgat-Ø	20 mm
Naaf lengte	40 mm
Temperatuur	- 20 / + 60 °C
Eigen gewicht	0.788 kg
Dyn. draagvermogen	350 kg
Statisch draagvermogen	700 kg
Hardheid van de band	A 92 Shore
Lager	6204ZV Nr.

Rolweerstand	+	+	+	+	+
Verplaatsingsgeluid	+	+	+	+	+
Strepen	+	+	+	+	+
Roest bescherming	+	+	+	+	+

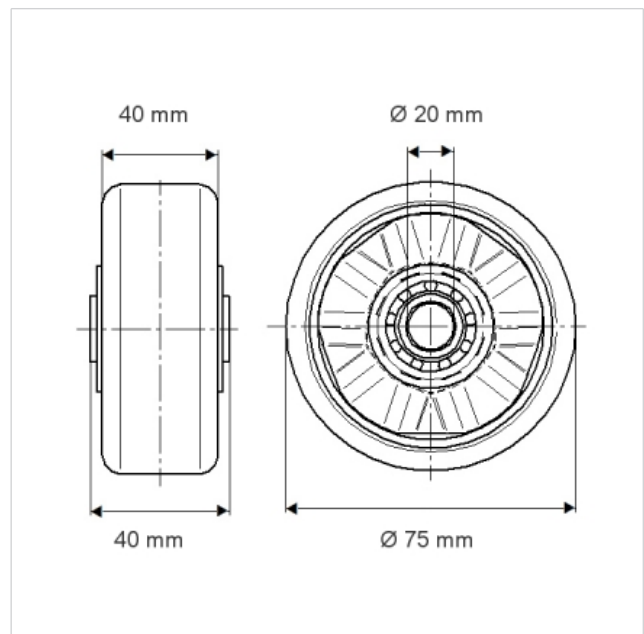



ETP075x40-Ø20 HL40

EAN 4031582318487

