

IEP250x50-Ø20

EAN 4031582319750

wielkern van aluminium op precisiekogellagers, met zwarte opge vulcaniseerde elastische rubberband

Technische data

Wieldiameter	250 mm
Bandbreedte	50 mm
Asgat-Ø	20 mm
Naaflengte	60 mm
Temperatuur	- 20 / + 85 °C
Standaard	EN 12532
Eigen gewicht	2.37 kg
Dyn. draagvermogen	500 kg
Statisch draagvermogen	1000 kg
Hardheid van de band	A 67 Shore



Rolweerstand	+	+	+	+	+
Verplaatsingsgeluid	+	+	+	+	+
Strepen	+	+	+	+	+
Roest bescherming	+	+	+	+	+

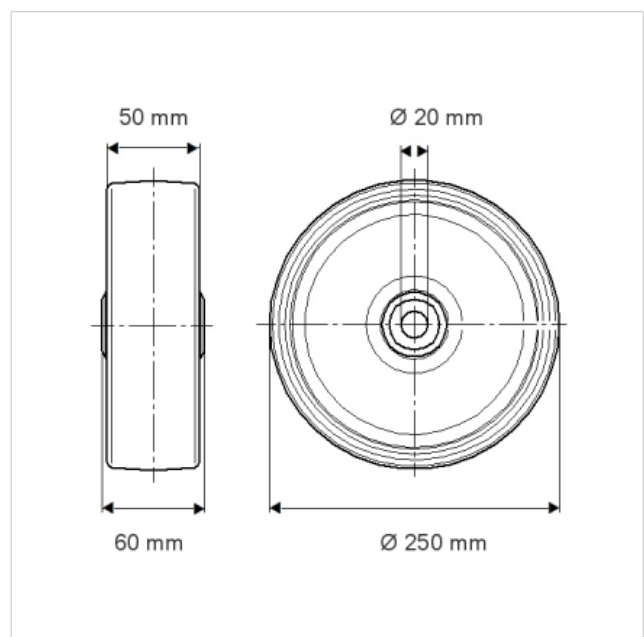



IEP250x50-Ø20

EAN 4031582319750

